

GAMMA ULTRA SERIES



ULTRA
Range

Motors

Type - external rotor, squirrel cage induction motor
 Electricity supply - 230V, single and 415V, three-phase, 50Hz
 Bearings - sealed-for-life, ball
 Speed-controllable using electronic or auto-transformer controllers
 Most three-phase units are fitted with 2-speed star/delta design motors
 See page O-2/3 for details on these motors

DESCRIPTION

The Gamma Ultra Series of Mixed-Flow roof units has been designed for use in commercial ducted exhaust applications. These compact and low profile units are fitted with birdmesh to prevent the entry of birds and vermin into the ducting or building. They are available in 9 sizes, extending from 250 to 630mm diameter.

Typical Applications

Exhaust air from a wide range of commercial applications such as factories, warehouses and workshops, change rooms, bulk goods retail outlets and assembly halls.

Features

- Robust, lightweight construction.
- Choice of speeds available.
- Compact, low profile design.
- Designed for downflow or vertical exhaust applications.
- Shutters are an optional extra for single fan units.
The pressure loss across the shutter has to be added to the system pressure before making selections.
- Can be mounted at angle up to 30°.
- Most 3-phase motors are 2-speed star/delta design.

Construction

Cowls are UV-stabilised plastic.
 Impellers are Mixed-Flow design and made from high performance injection moulded composite material.
 Steel components have a corrosion resistant finish.
 Bird-mesh guards are fitted as standard to both downflow and vertical exhaust models.

Internal Thermal Protection

Thermal protection is supplied as standard on all motors.

Testing

Air flow tests based on ISO5801
 Noise tests based on ISO13347-3

Wiring Diagram

See page N-8, diagram ER 1, 2, 4, 5.

HOW TO ORDER

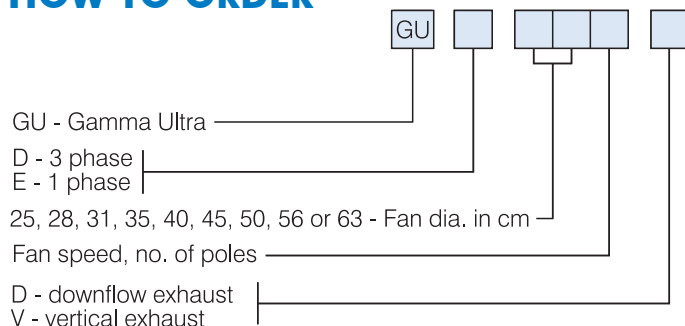

DIMENSIONS

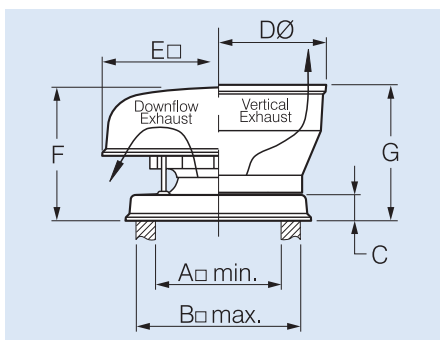

Model No.	Dimensions, mm							Approx. weight kg.
GUE... GUD...	A	B	C	DØ	E	F	G	
250-280	310	410	75	500	570	345	341	9
315-355	400	500	75	640	670	390	433	14
400-500	620	720	75	908	890	532	537	32
560-630	710	810	75	1260	1180	642	674	83

TECHNICAL DATA

Model GUE...D/V GUD...D/V	Nom. Speed r/s	Max Operating Temp. °C		GUD...V AVG. dB(A) @ 3M	GUE...V 1 ph		GUD...V 3 ph		Free-field Sound Power Levels, dB							
					kW	Amps*	kW	Amps*	63	125	250	500	1k	2k	4k	8k
254.**	24	60	Inlet	41	0.10	0.48	-	-	64	60	61	58	58	55	49	42
			Outlet	46					65	63	64	63	61	61	53	44
284.**	24	60	Inlet	44	0.13	0.66	-	-	68	63	65	61	60	58	53	46
			Outlet	49					70	66	69	67	64	64	57	48
314.	23	60	Inlet	45	0.22	1.10	0.21	0.50	68	66	66	63	61	58	54	47
			Outlet	50					69	70	69	69	66	64	58	51
316.	15	60	Inlet	39	0.09	0.48	0.09	0.26	66	62	59	56	57	51	43	33
			Outlet	44					66	64	61	62	60	57	47	37
318.	13	60	Inlet	36	-	-	0.05	0.11	63	59	56	53	54	48	40	30
			Outlet	40					63	61	58	59	57	54	44	34
354.	23	60	Inlet	46	0.37	1.85	0.33	0.68	69	69	68	64	62	60	55	47
			Outlet	51					71	73	72	70	67	64	58	50
356.	16	60	Inlet	40	0.12	0.56	0.13	0.36	66	64	65	56	55	53	45	32
			Outlet	44					67	66	66	62	60	56	47	35
358.	13	60	Inlet	37	-	-	0.07	0.14	62	60	61	52	51	49	41	28
			Outlet	40					62	62	62	58	56	52	43	31
404.	22	60	Inlet	50	0.58	2.60	0.54	1.20	70	72	73	68	66	63	58	53
			Outlet	55					66	76	79	72	72	67	61	54
406.	15	60	Inlet	45	0.28	1.35	0.22	0.56	66	67	69	62	60	58	51	42
			Outlet	50					61	69	73	66	67	61	52	42
408.	11	60	Inlet	38	-	-	0.13	0.28	59	60	62	55	53	51	44	35
			Outlet	43					54	62	66	59	60	54	45	35
454.	23	60	Inlet	56	1.10	5.20	1.00	1.95	76	77	80	72	70	69	65	59
			Outlet	61					79	83	86	77	76	72	68	60
456.	15	60	Inlet	45	0.37	1.75	0.32	0.70	68	69	68	62	61	59	51	41
			Outlet	50					61	71	74	67	67	62	53	42
458.	9	60	Inlet	33	-	-	0.19	0.39	55	56	55	49	48	46	38	28
			Outlet	38					48	58	61	54	54	49	40	29
504.	21	60	Inlet	58	1.65	7.40	1.45	2.80	81	82	78	74	72	72	68	63
			Outlet	63					85	88	85	80	79	74	71	63
506.	14	60	Inlet	50	0.54	2.50	0.48	0.88	71	76	69	64	65	66	58	51
			Outlet	54					76	78	75	69	71	66	60	48
508.	11	60	Inlet	43	-	-	0.31	0.50	64	69	62	57	58	59	51	44
			Outlet	47					69	71	68	62	64	59	53	41
564.	22	45	Inlet	59	-	-	2.50	4.60	79	84	80	75	76	73	68	65
			Outlet	63					82	86	85	81	80	75	71	64
566.	15	60	Inlet	52	0.84	4.20	0.86	2.20	71	61	68	65	70	66	60	54
			Outlet	55					58	69	72	72	73	68	62	50
568.	13	60	Inlet	48	-	-	0.62	1.10	67	67	64	61	66	62	56	50
			Outlet	51					54	65	68	68	69	64	58	46
636.	15	60	Inlet	54	-	-	1.35	3.40	70	74	72	68	71	69	62	58
			Outlet	57					59	74	76	75	74	70	64	52
638.	12	60	Inlet	48	-	-	0.86	1.85	64	68	66	62	65	63	56	52
			Outlet	51					53	68	70	69	68	64	58	46

All motors except 254 and 284 are two speed

** Available in single phase only

* Amperages shown are a guide only, refer to our Sales Department for accurate figures at time of order.

GAMMA ULTRA SERIES

ULTRA
Range



SUGGESTED SPECIFICATION

Downflow Exhaust Series

The roof ventilators shall be of the Gamma Ultra Series downflow exhaust type as designed and manufactured by Fantech Pty. Ltd. and be of the model numbers shown on the schedule/drawings.

Impellers shall be made from high performance injection moulded composite material. They shall be Mixed-Flow design and driven by speed-controllable external rotor motors with integral thermal overload protection.

The cowl shall be of the downflow exhaust design and formed from plastic. Steel components are corrosion protected.

All performance data shall be for a complete assembled unit based on ISO5801 for air flow and ISO13347-3 for noise.

ANCILLARY EQUIPMENT

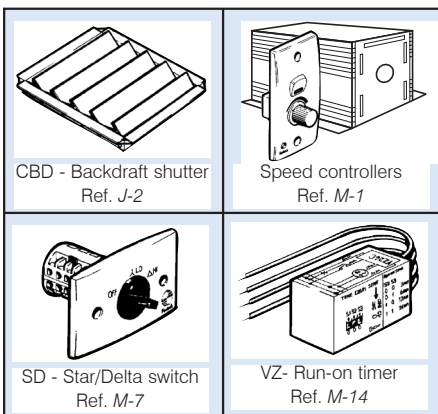

Scan the QR Code to view wiring diagrams or more information online.

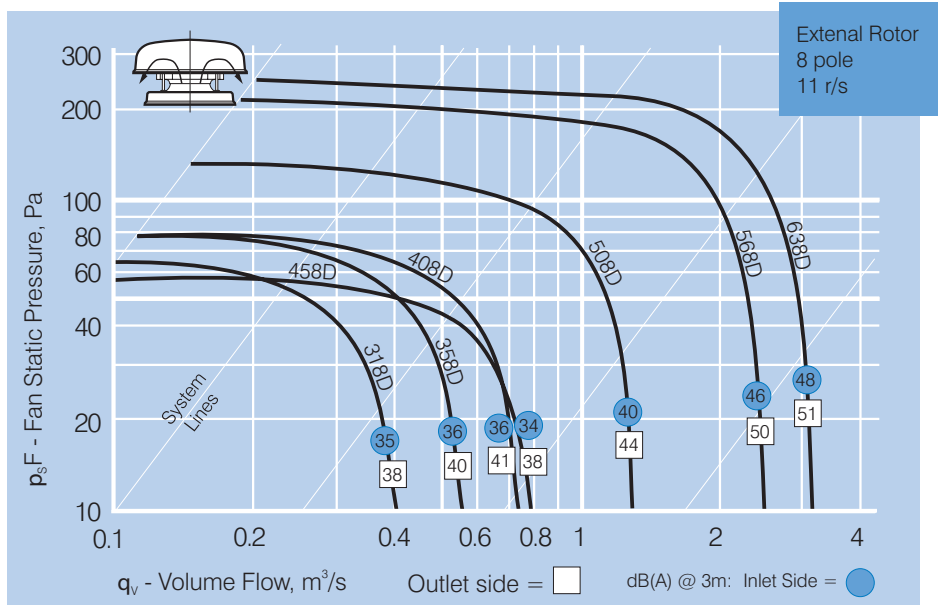
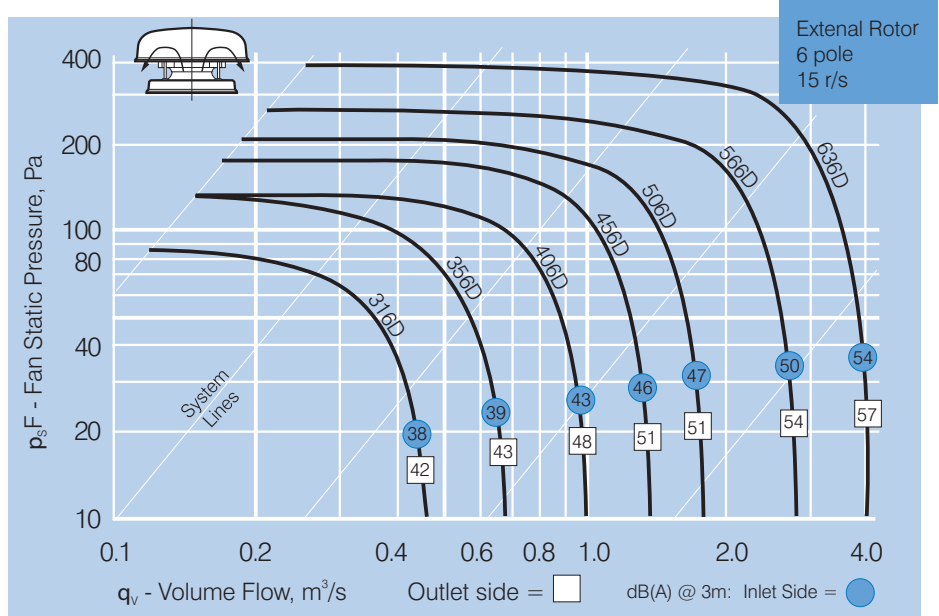
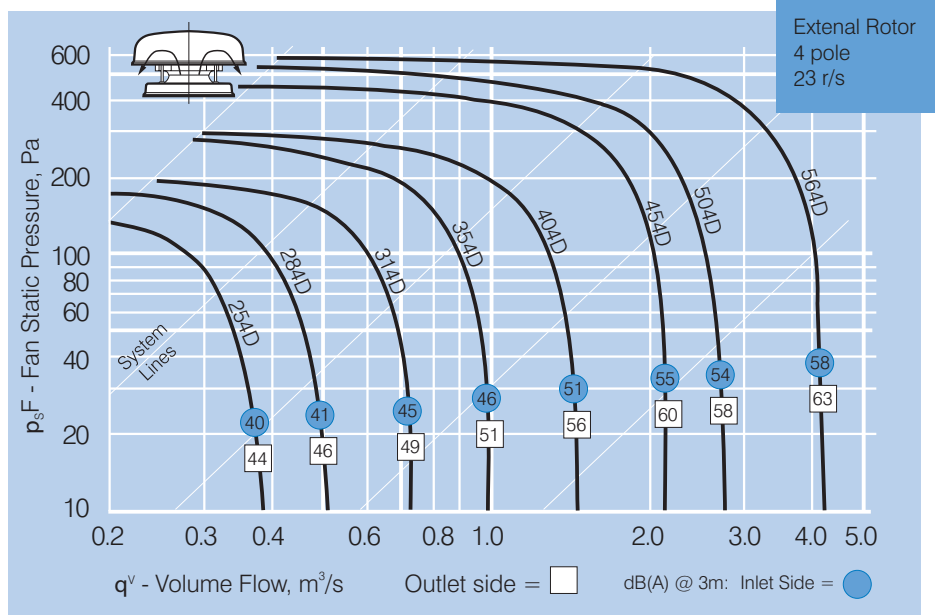

ULTRA
Range



SUGGESTED SPECIFICATION

Vertical Exhaust Series

The roof ventilators shall be of the Gamma Ultra Series vertical exhaust type as designed and manufactured by Fantech Pty. Ltd. and be of the model numbers shown on the schedule/drawing.

Impellers shall be made from high performance injection moulded composite material. They shall be Mixed-Flow design and driven by speed-controllable external rotor motors with integral thermal overload protection.

The windband shall be of the vertical exhaust design and formed from plastic. Steel components shall be corrosion protected.

All performance data shall be for a complete assembled unit based on ISO5801 for air flow and ISO13347-3 for noise.

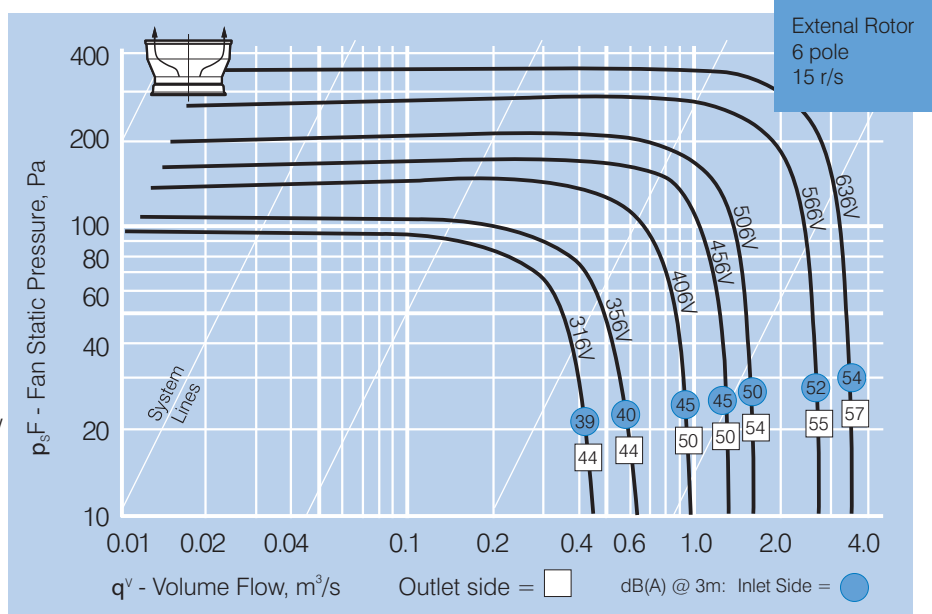
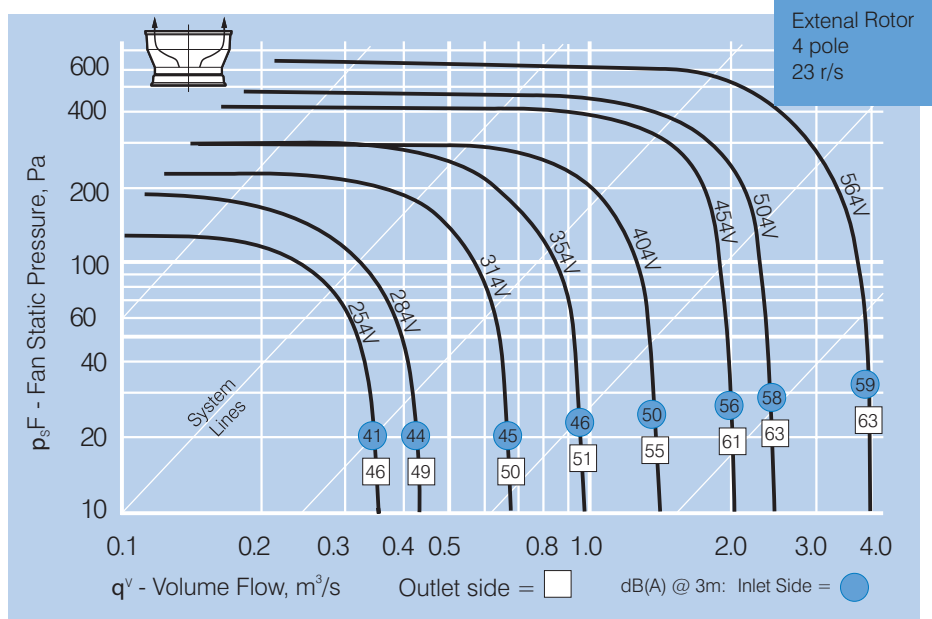

ANCILLARY EQUIPMENT

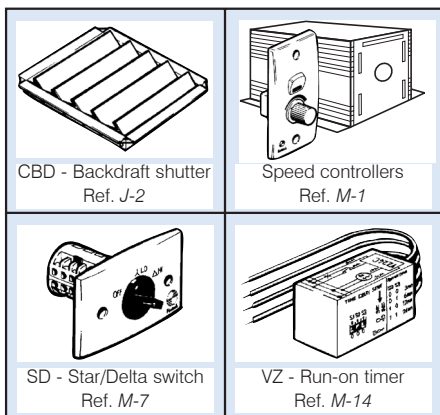

Scan the QR Code to view wiring diagrams or more information online.

