

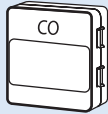



Ultra, Standard Height JetVent with mixed-flow Ultra impeller

Standard Height JetVent with centrifugal aluminium impeller

ANCILLARY EQUIPMENT

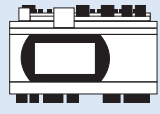
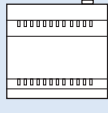
 CO/NO _x Sensor <i>Ref. F-8</i>	 Decentralised Smoke Detector <i>Ref. F-8</i>	 Aviator MAX/MINI Controller <i>Ref. Section M</i>
 Aviator MAX Expansion Module <i>Ref. Section M</i>	 Aviator 4.3" & 7" GUI <i>Ref. Section M</i>	 VLT - Variable Speed Drive <i>Ref. Section M</i>
 Aviator Fan Interface Module <i>Ref. Section M</i>	 Comlink Repeater Module <i>Ref. Section M</i>	 Supply & Exhaust Fans <i>Ref. Section C</i>

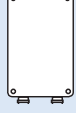
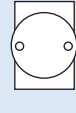
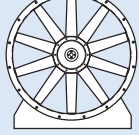
DESCRIPTION

Standard height JetVents are designed for typical car park layouts and ceiling heights. They use the same advanced digital EC motor technology, have a high speed thrust rating of up to 52 Newtons and a pre-set speed thrust rating of up to 38.5 Newtons.

The Standard height JetVent fan is available with two impeller variations. The centrifugal aluminium type impeller is designed to produce a high volume air flow (at high speed). The second model features a cutting edge mixed-flow impeller that is designed to be quieter and ultra-energy efficient.

Features

- All SD and USD JetVents are three phase EC models.
- An energy efficient ventilation system that provides the ventilation rate according to the CO or NO_x pollutant levels in the space.
- Available with a factory fitted and fully integrated smoke detection kit mounted to the side of the JetVent fan.
- Additional decentralised smoke detectors can be connected to the JetVent system based on car park layout.
- Utilises Aviator controls to digitally connect JetVent fans, Supply & Exhaust fans, Sensors and the BMS together.
- Aviator controls with propriety ComLink system provides a simple control wiring scheme with easy installation, fast commissioning and a high level of system monitoring.
- EC motor features reverse polarity protection, locked rotor protection and soft starting.
- EC motor technology eliminates the need for external VSDs, current overloads and motor phase protection.

Construction

Low-profile galvanised steel housing with aerodynamically designed internal flow elements. Light grey powder coated finish as standard. The Standard model (SD) has a backward-curved centrifugal impeller made from durable aluminium. The Ultra Standard model (USD) has a mixed-flow impeller made from high performance injection moulded composite material.

Internal Thermal Protection

Integral thermal overload protection is supplied as standard..

Wiring Diagram

Refer to the latest JetVent Carpark Ventilation Solutions Application Guide for an overview of wiring schemes. Contact your Fantech sales engineering team for further information.

Motors

Type - Electronically commutated (EC) Motor.

Electricity supply: 380V-480V, three-phase, 50/60 Hz.

Bearings - sealed-for-life ball.

See *page O-7* for details on motors.

Integrated EC-Controller providing infinite speed control.

Integrated EC speed control over analogue 0-10V or 4-20mA, PWM or MODBUS High Level Interface over RS485.

Testing

Thrust-air performance based on tests to BS848 Part 10,1999: "Fans for general purpose - Performance testing of jet fans."

Noise data based on tests to BS848: Part 2:1985.

Special Note

In most cases Jet fans will be treated as a mechanical performance solution within the National Construction Code (NCC) (formally the BCA). Where required, a mechanical performance solution should comply with the AFAC Guideline 1.0 on Fire Safety for impulse (Jet) fans in Car Parks, and be approved by the appropriate authority. The mechanical performance solution should contain a pollutant analysis and detailed justification to demonstrate the jet fan system will not have a significant detrimental effect on the safe egress of occupants or operation of the sprinkler system.

JETVENT CAR PARK EC FANS - SD & USD SERIES

SUGGESTED SPECIFICATION

The high velocity jet fans shall be of the standard height JetVent JIU-CPCEC Series as designed and manufactured by Fantech Pty Ltd and be of the model numbers shown on the schedule/drawings. The impellers must be driven by EC external rotor motors with integrated EC-Controller and integral thermal overload protection. They shall be pre-configured to suit CO/NO_x sensors and the required applications.

The housing shall be of galvanised steel with a light grey powder coated finish as standard. They shall incorporate mounting feet and aerodynamically designed internal flow elements.

Performance data shall be based on tests to BS848:Part 10,1999 for thrust and ISO3744 or ISO13347-3 for noise.

HOW TO ORDER

Step 1

Select the digital EC JetVent fan model

JIU-JetVent Induction

CPCEC - CarPark Centrifugal, EC Motor

SD - Standard Height

USD - Ultra Standard Height

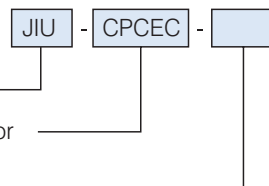

Step 2

Select isolator or smoke detection kit

Smoke Detector Kit

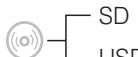

JIU-SMOKEKIT

or

Isolator Kit



JIU-ISOLATORKIT

Refer to the latest JetVent Carpark Ventilation Solutions Application Guide for further selection information.

DIMENSIONS

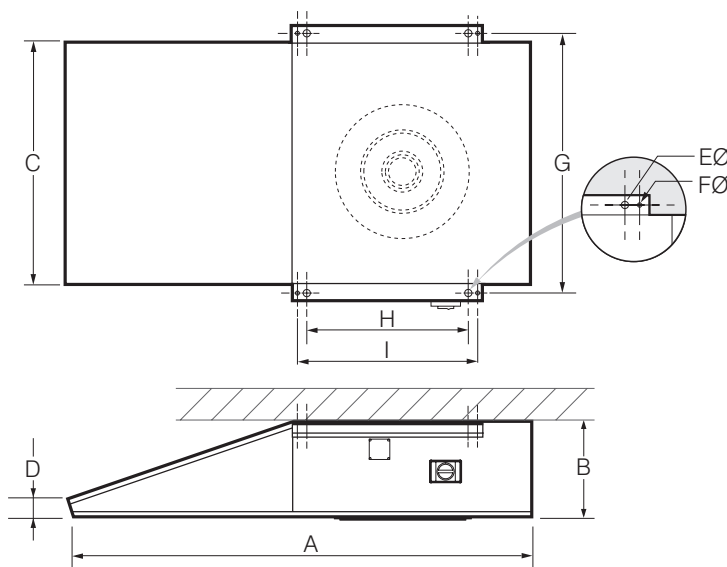

Scan the QR Code to view more information online.



Model	Dimensions, mm									Approx. wt. kg
	A	B	C	D	EØ	FØ	G	H	I	
SD	1745	370	906	68	25	13	973	605	675	89
USD										

TECHNICAL AND NOISE DATA

Model	Fan Speed rev/sec	Free Air m ³ /s	Thrust N	JIU-CPCEC-...				Car park Installed Noise Levels dB(A)#	Free-field Noise Rating dB(A) @ 3m**	Sound Power Levels L _w dB re 1pW							
				3 ph. kW	Amps	Max. °C	63			125	250	500	1k	2k	4k	8k	
SD	High Speed	30	1.64	52.2	1.7	2.5	40	72	64	79	80	83	81	79	78	74	74
	Pre-set Speed*	22	1.20	28.4	0.7~	1.1	40	65	57	74	79	73	72	72	71	67	63
USD	High Speed	24	1.39	38	1.1	1.8	60	67	60	75	85	78	74	75	74	70	64
	Pre-set Speed*	23	1.34	36.5	1.1~	1.8	60	65	59	74	84	77	73	75	73	69	63

Car park installed noise levels apply 8m away from the fan with multiple fans operating.

** Free-field noise rating applies 3m away from the fan with single fan operating.

~ Estimated power consumption.

* Pre-set speed so fan does not operate above the AS2107:2016 recommended noise level of 65dB(A) @ 8m.